

**Bednář: sedlák, sedlík**

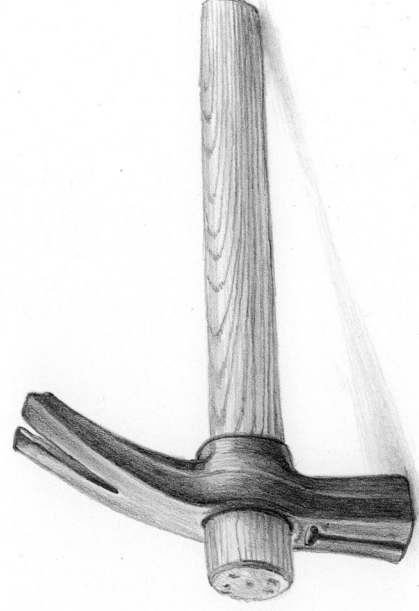

**Bednář: kladivo**

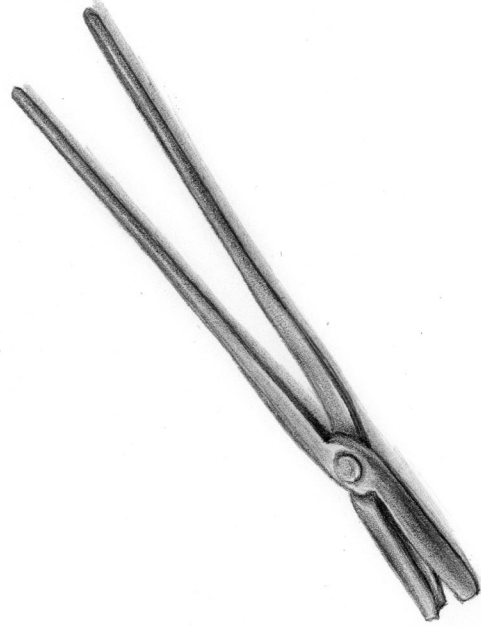

**Kovář: kleště**



**Bednář: dřevěná palice**

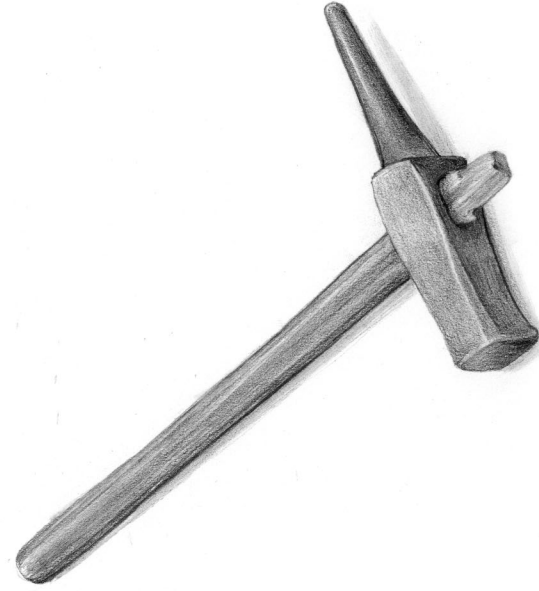

**Kovář: kladívko**



**Bednář: sedlák, sedlík**



Kovář: pilník



Kovář: kovadlina



Kolář: nebozez



Kolář: kružidlo



Kolář: poříz

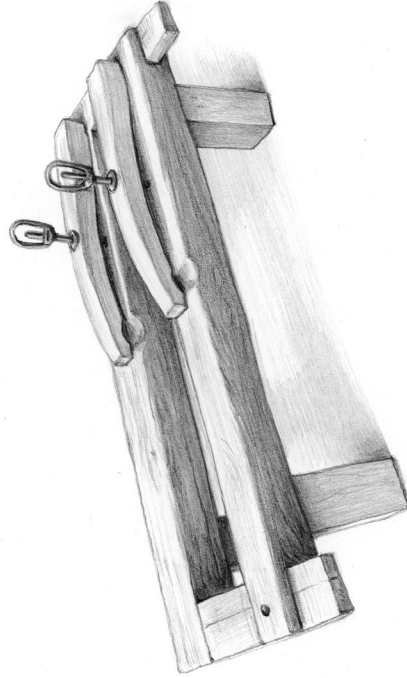

Kolář: štok

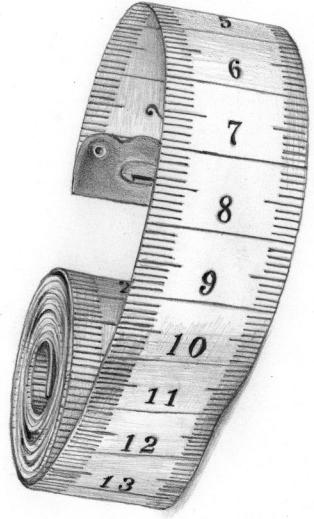

Krejčí: metr

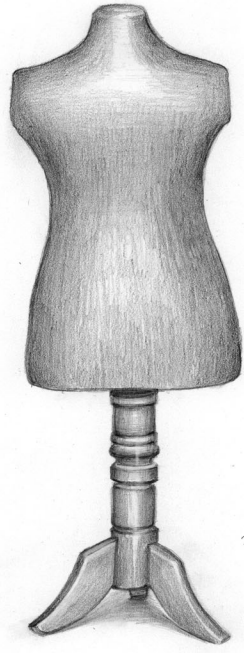

Krejčí: panna



Krejčí: nůžky



Krejčí: jehelník



Pekař: kartáč

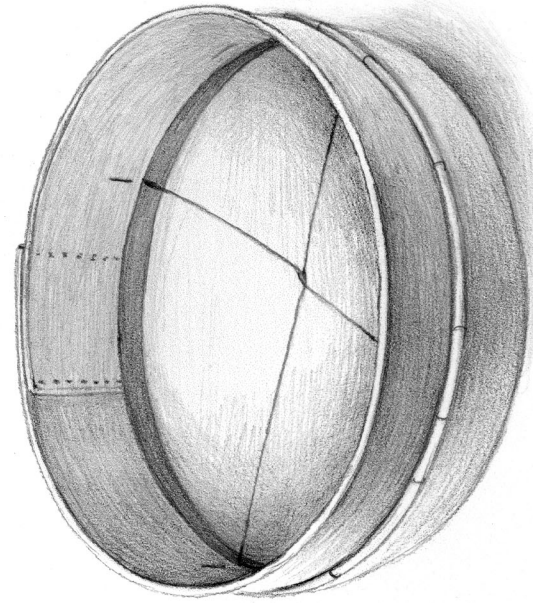

Pekař: řešeto



Platněř: průvlak ( k tahání drátů )



Pekař: lopata



Platněř: kladivo



Pekař: ošatka

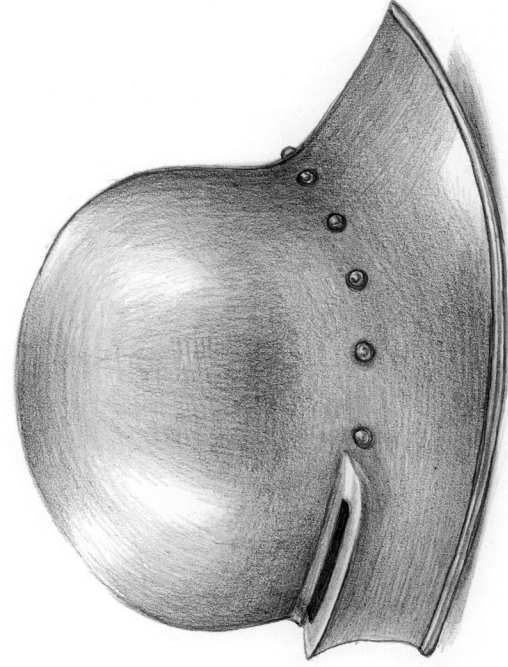

Platněř: šaliř



Platněř: kleště ( k nýtování )

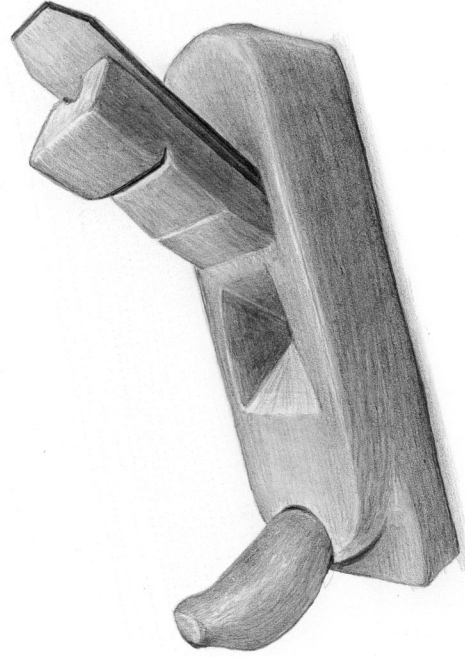

Truhlář: hoblík



Řezník: sekáček



Truhlář: dřevěná palice



Řezník: sekyra



Truhlář: rašple

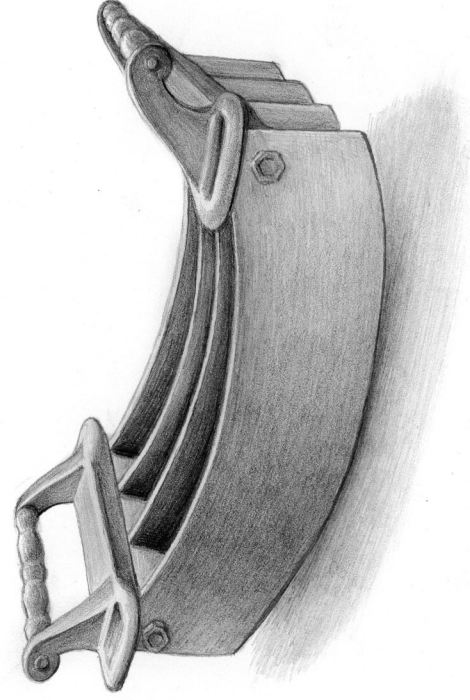

Řezník: kolébka ( na krájení )

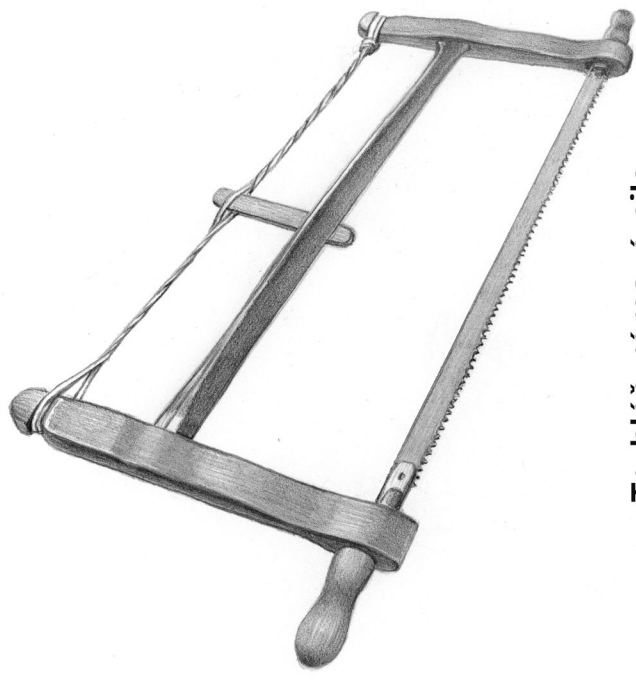

Truhlář: rámová pila



Zedník: naběračka

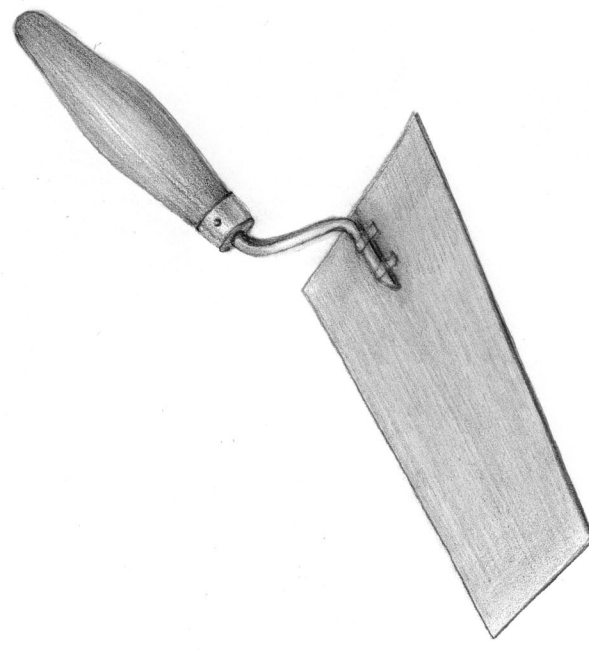

Zedník: lžíce



Zedník: vodováha



Zedník: hladítko